

# Three and Single phase motor driver ICs

KA44143A / KA44168A / KA44169A / KA44169AB / KA44170A

## DESCRIPTION

Nuvoton's motor driver IC incorporate APC (Auto Phase Control) technology to correct the phase delay by detecting motor current automatically. With APC, there is no need for adjustment of phase. It helps to eliminate phase delay due to motor variation or deterioration and therefore realize a high efficiency, reliability and safety motor system.

## FEATURES

- Auto phase shift correction with built-in Soft Switching function contributes to high-efficiency drive, common PCB design, and easy motor system design.
- Wide range operation  
Single phase : 12V, 24V \*1  
Three phase : 5V, 12V, 24V  
(\*1 : KA44171A can use 48V with external parts)
- AEC-Q100 Grade-2 : KA44143A

## APPLICATION

- Cooling fan for Refrigerator, Factory automation, Server, Cellular Base station

## TECHNOLOGY

- IC always detects the motor current and automatically controls the motor current phase. (APC : Auto Phase Control)



TSSOP-14



MSOP-8

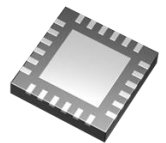

HQFN-24

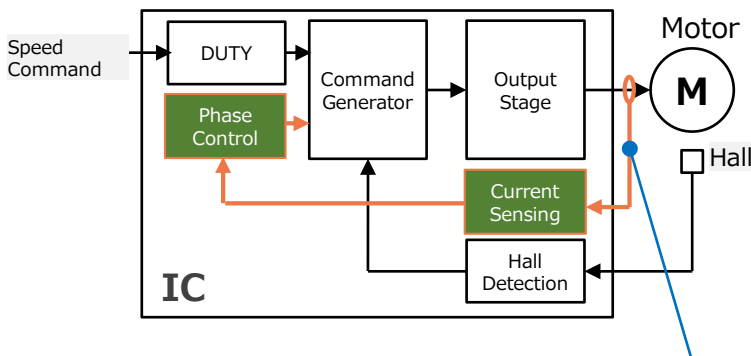

IC always detects the motor current

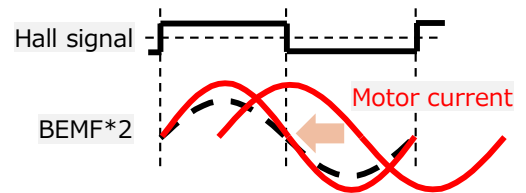

automatically controls the motor current phase

(\*2 : Back Electromotive Force)

The products and product specifications described in this document are subject to change without notice for modification and/or improvement. At the final stage of your design, purchasing, or use of the products, therefore, ask for the most up-to-date Product Standards in advance to make sure that the latest specifications satisfy your requirements.

# Motor driver IC for high speed rotation

## KA44171A

### DESCRIPTION

Nuvoton's motor driver IC incorporate APRaS (Advanced Phase & Rapid Softswitch) technology. For application of high speed rotation, just advanced phase function itself is adopted generally, but it's not enough at the point of efficiency. Then in order to obtain high speed rotation at high efficiency, implemented rapid softswitch, that enables to adjust the rise / fall slope of motor current.

### FEATURES

- Advanced phase control with rapid softswitch function contributes to higher rotation speed.
- Wide range operation  
Single phase : 12V, 24V \*1  
(\*1 : KA44171A can support 48V with external parts )

### APPLICATION

- Cooling fan for Server, Cellular Base station, Factory automation





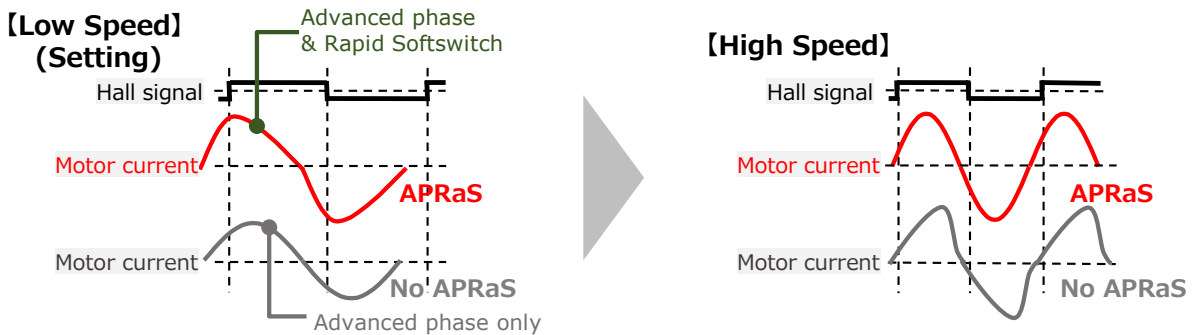
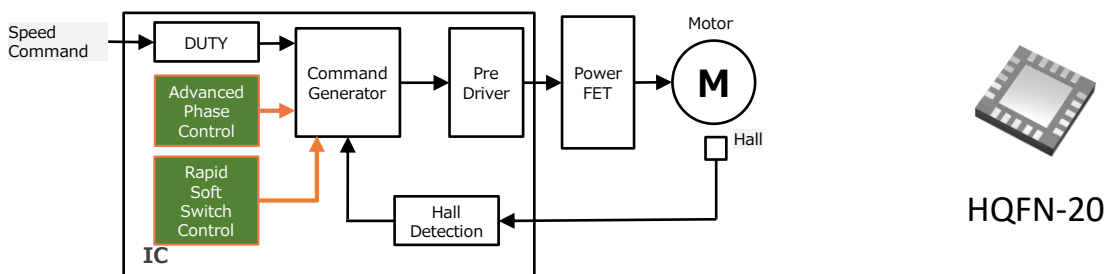

### TECHNOLOGY

- IC advance the motor current phase and enable to set more than 100krpm with rapid softswitch function.  
(APRaS : Advanced Phase & Rapid Softswitch)



The products and product specifications described in this document are subject to change without notice for modification and/or improvement. At the final stage of your design, purchasing, or use of the products, therefore, ask for the most up-to-date Product Standards in advance to make sure that the latest specifications satisfy your requirements.

## ■ Products Lineup

P/N	KA44143A	KA44168A	KA44169A	KA44169AB	KA44170A	KA44171A
Motor type	Three phase	Single phase				
Feature	High efficiency (APC) *2	High efficiency (APC) *2	High efficiency (APC) *2	High efficiency (APC) *2	High efficiency (APC) *2	High speed (APRaS) *3
Operating voltage [V]	4.5 to 26.4	5.0 to 28	5.0 to 28	5.6 to 28	5.0 to 30	5.0 to 36 *4
Absolute max rating [V]	28	35	36	36	36	39
Absolute max rating [A]	2.2	1.0	1.4	1.4	1.6	0.03
Ron [ $\Omega$ ] *1	1.0	1.6	1.6	1.6	1.25	Pre-driver
Input I/F	DC/PWM	-	PWM	DC	PWM	PWM/DC
Output I/F	FG/LD	FG	FG/LD	FG	FG/LD	FG/LD (selectable)
Package Type	HQFN-24	MSOP-8	TSSOP-14	TSSOP-14	TSSOP-14	HQFN-20
Package Size [mm]	4.0×4.0×0.8	3.0×4.9×1.1	5.0×6.4×1.1	5.0×6.4×1.1	5.0×6.4×1.1	3.0×3.0×0.75
Pin Pitch [mm]	0.5	0.65	0.65	0.65	0.65	0.4
Package appearance						

- \*1 Sum of upper and lower FET
- \*2 Auto Phase Control
- \*3 Adjustable with external settings
- \*4 KA44171A can support 48V with external parts

<https://www.nuvoton.com/products/motor-drivers/motor-driver-ics/>

The products and product specifications described in this document are subject to change without notice for modification and/or improvement. At the final stage of your design, purchasing, or use of the products, therefore, ask for the most up-to-date Product Standards in advance to make sure that the latest specifications satisfy your requirements.

As of Sep. 01, 2022

**Nuvoton Technology Corporation Japan**

<https://www.nuvoton.co.jp/en/>